

## Plastic-Encapsulate Diodes

### Bi-direction ESD Protection Diode

#### DESCRIPTION

Designed to protect voltage sensitive electronic components from ESD and other transients. Excellent clamping capability, low leakage, low capacitance, and fast response time provide best in class protection on designs that are exposed to ESD.

The combination of small size, low capacitance, and high level of ESD protection makes them a flexible solution for applications such as HDMI, Display Port TM, and MDDI interfaces. It is designed to replace multiplayer varistors (MLV) in consumer equipments applications such as mobile phone, notebook, PAD, STB, LCD TV etc.

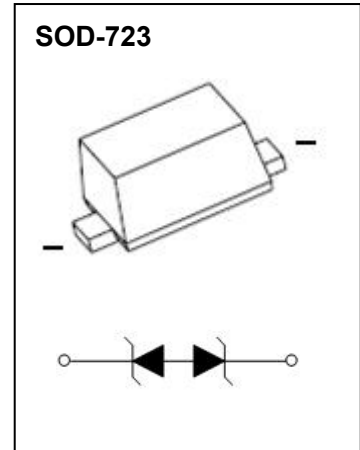

#### FEATURES

- Bi-directional ESD protection of one line
- Low capacitance: 12pF(Typ.)
- Low reverse stand-off voltage: 5.0V
- Low reverse clamping voltage
- Low leakage current
- Excellent package: 1.00mm×0.6mm×0.55mm
- Fast response time
- JESD22-A114-B ESD Rating of class 3B per human body model
- IEC 61000-4-2 Level 4 ESD protection

#### APPLICATIONS

- Computers and peripherals
- PAD
- Audio and video equipment
- Cellular handsets and accessories
- Subscriber identity module(SIM) card protection
- Portable electronics
- Other electronics equipments communication systems

#### MARKING

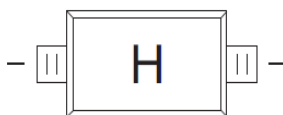

Front side

H = Device code

**MAXIMUM RATINGS (  $T_a=25^{\circ}\text{C}$  unless otherwise noted )**

Parameter	Symbol	Limit	Unit
IEC 61000-4-2 ESD Voltage	Air Model	$\pm 25$	kV
	Contact Model	$\pm 25$	
	Per Human Body Model	$\pm 16$	
	Machine Model	$\pm 0.4$	
Peak Pulse Power	$P_{PP}^{(2)}$	50	W
Peak Pulse Current	$I_{PP}^{(2)}$	5	A
Lead Solder Temperature – Maximum (10 Second Duration)	$T_L$	260	$^{\circ}\text{C}$
Operation Junction and Storage Temperature Range	$T_J, T_{stg}$	-55 ~ +150	$^{\circ}\text{C}$

(1).Device stressed with ten non-repetitive ESD pulses.

(2).Non-repetitive current pulse 8/20 $\mu\text{s}$  exponential decay waveform according to IEC61000-4-5.

**ESD standards compliance**

**IEC61000-4-2 Standard**

Contact Discharge		Air Discharge	
Level	Test Voltage kV	Level	Test Voltage kV
1	2	1	2
2	4	2	4
3	6	3	8
4	8	4	15

**JESD22-A114-B Standard**

ESD Class	Human Body Discharge V
0	0 ~ 249
1A	250 ~ 499
1B	500 ~ 999
1C	1000 ~ 1999
2	2000 ~ 3999
3A	4000 ~ 7999
3B	8000 ~ 15999

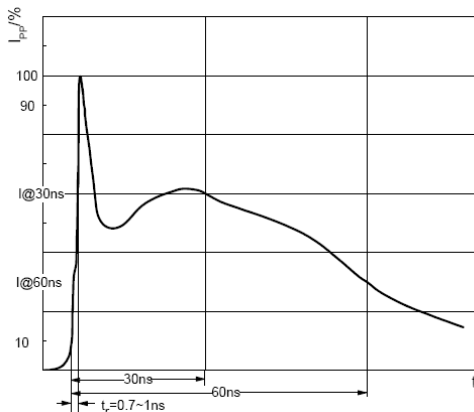

ESD pulse waveform according to IEC61000-4-2

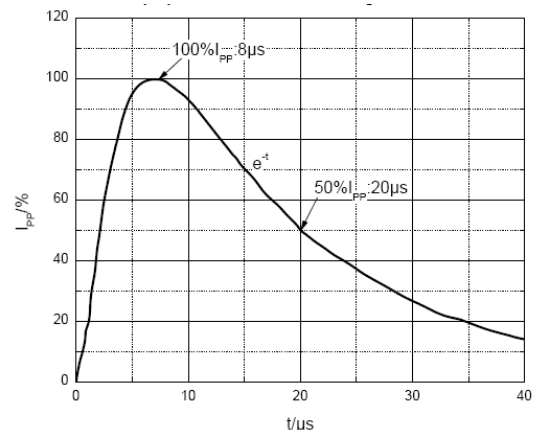

8/20 $\mu\text{s}$  pulse waveform according to IEC 61000-4-5

### ELECTRICAL PARAMETER

Symbol	Parameter
$V_C$	Clamping Voltage @ $I_{PP}$
$I_{PP}$	Peak Pulse Current
$V_{BR}$	Breakdown Voltage @ $I_T$
$I_T$	Test Current
$I_R$	Reverse Leakage Current @ $V_{RWM}$
$V_{RWM}$	Reverse Standoff Voltage

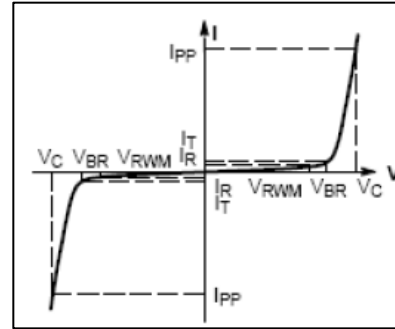

V-I characteristics for a Bi-directional TVS

### ELECTRICAL CHARACTERISTICS ( $T_a=25^\circ\text{C}$ unless otherwise specified)

Parameter	Symbol	Test conditions	Min	Typ	Max	Unit
Reverse stand off voltage	$V_{RWM}^{(1)}$				5	V
Reverse leakage current	$I_R$	$V_{RWM}=5\text{V}$			0.1	$\mu\text{A}$
Breakdown voltage	$V_{(BR)}$	$I_T=1\text{mA}$	5.8		7.8	V
Clamping voltage	$V_C^{(2)}$	$I_{PP}=5\text{A}$			10	V
Junction capacitance	$C_J$	$V_R=0\text{V}, f=1\text{MHz}$		12	15	pF

(1). Other voltages available upon request.

(2). Non-repetitive current pulse 8/20 $\mu\text{s}$  exponential decay waveform according to IEC61000-4-5

### TYPICAL CHARACTERISTICS

Reverse Characteristics

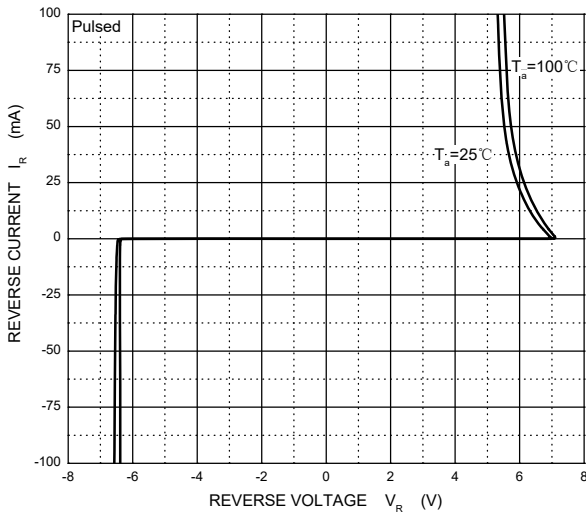

Capacitance Characteristics

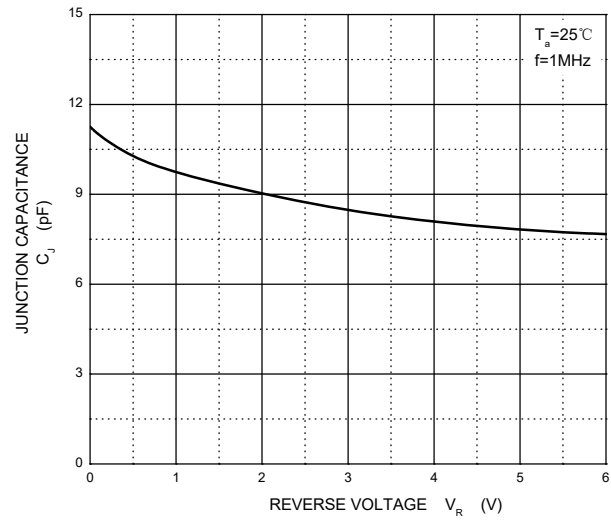

$V_C$  —  $I_{PP}$

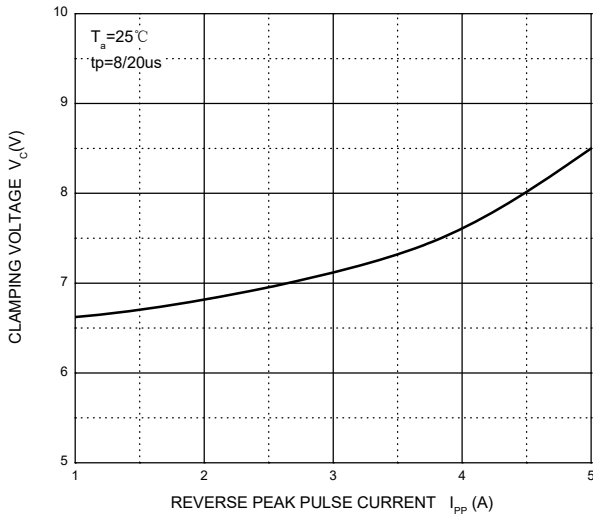



## SOD-723-Package Outline Dimensions

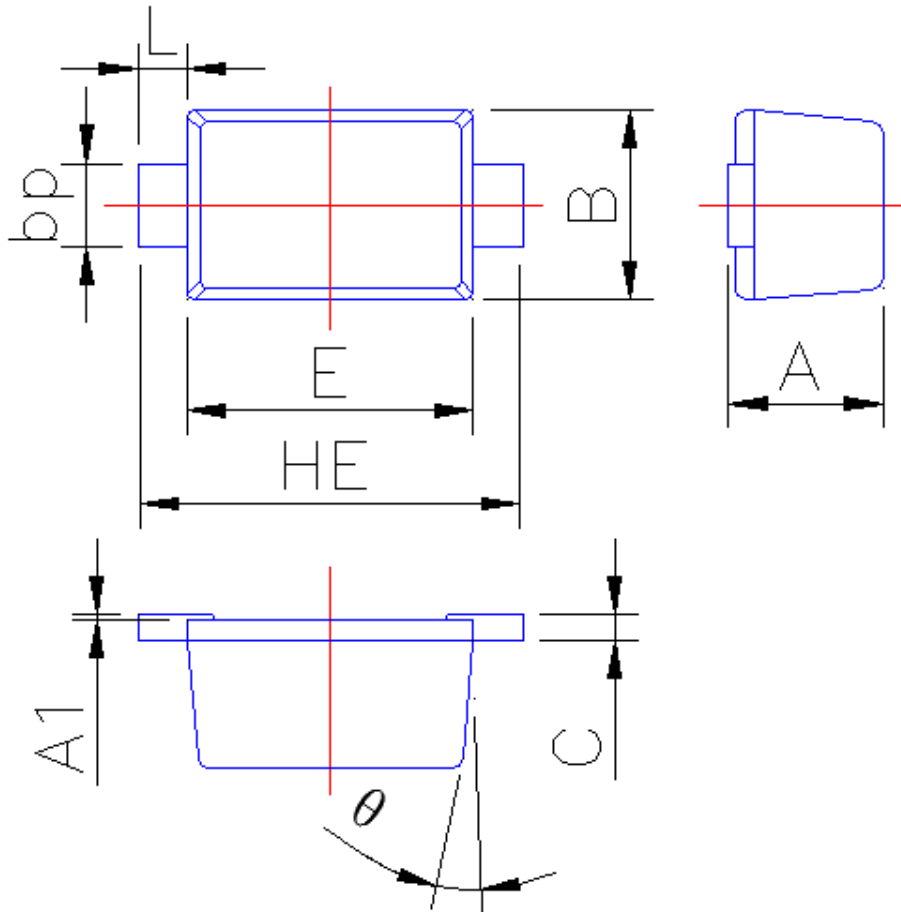

Symbol	Dimension in Millimeters	
	Min	Max
A	0.515	0.580
A1	0.010	0.070
B	0.550	0.650
bp	0.250	0.350
C	0.08	0.150
E	0.900	1.100
HE	1.30	1.50
L	0.150	0.250
θ	7°	